

BUY NOW 

DC-20KHz Driver for NanoSpeed™ VOA

(patents pending)

Product Description

The NS VOA Driver provides driving signals for the NS series solid state VOAs. The push-pull output design ensures fast switching time for both rising and falling edges, and it is especially suitable for driving capacitive VOA loads.

The standard driver controls one individual VOA. Drivers that control multiple VOAs also are available, please call Sales at (781) 935-1200 for more information.

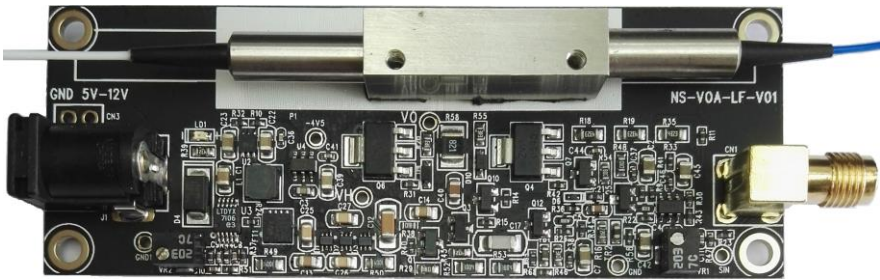

Features

- High Speed
- High Output Voltage
- Wide Input Voltage Range
- TTL/CMOS/Other Control
- Push-Pull Output Design
- Low Power Consumption

Performance Specifications

Specs	Min	Typical	Max	Unit
Rising Speed (Sr) [1]	450	600	750	ns
Falling Speed (Sf) [2]	450	600	750	ns
Repetition Rate	DC		20	KHz
Pulse Width [3]	1.0			us
Input Control Voltage [4]	0	4.5	5	V
Power Consumption [5]			1.3	W
Power Supply	5		12	V
Operating Temperature	-5		70	°C
Storage Temperature	-40		80	°C
Electrical Connector	SMA			
Board Size	3.5(L)x1.25(W)			Inch

Note:
 [1]: Duration from begin of electronic signal to end of optic intensity change
 [2]: Duration from begin of electronic signal to end of optic intensity change
 [3]: Pulse working mode
 [4]: For full attenuation. Low voltage version is available, see the order information.
 [5]: Dependent on repetition frequency, measured at 20kHz

Applications

- Optical VOA
- Optical Switch
- Optical Modulator

DC-20KHz Driver for NanoSpeed™ VOA

Electric-Optic Switching Response

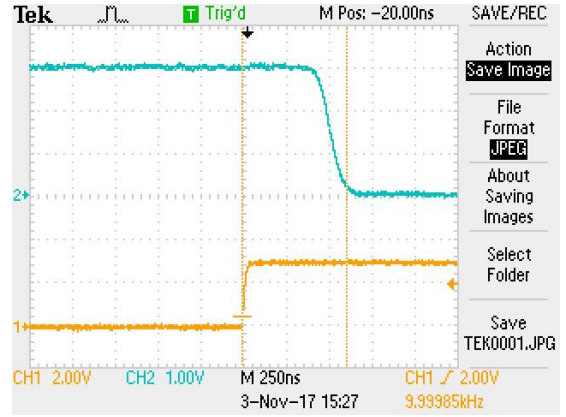
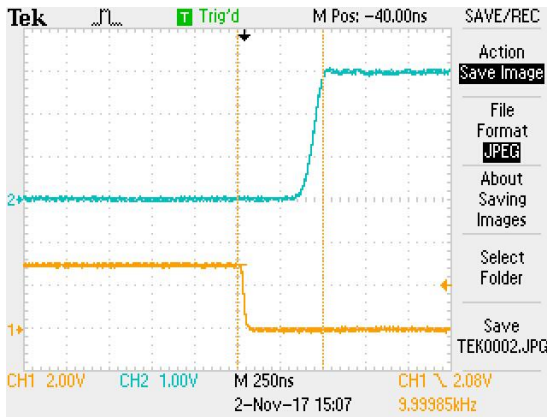

Power Consumption

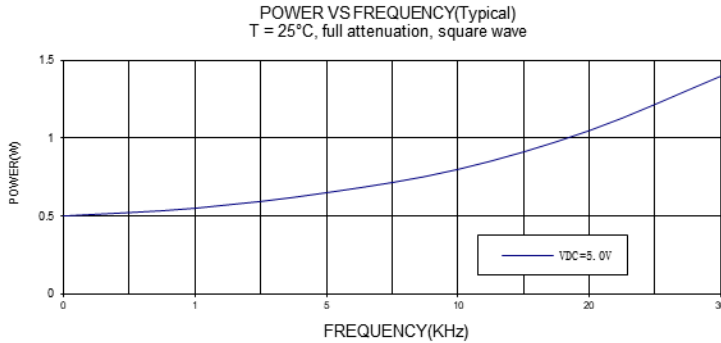

Ordering Information

NVDR-	1 1	3	2	<input type="checkbox"/>	<input type="checkbox"/>	<input type="checkbox"/> <input type="checkbox"/>	<input type="checkbox"/>
	Type	Repetition		Size	Input control voltage	# of VOA	Connector
		DC-20KHz=3 Special=0		3.5"×1.25" = 3 Special=0	3.3V version = 3 5.0V version = 5	Single VOA =11 Special=00	SMA=2 Special=0

*Product dimensions may change without notice. This is sometimes required for non-standard specifications.

DC-20KHz Driver for NanoSpeed™ VOA

Power Connector

P/N: [SC1313-ND](#)

Power Barrel Connector Jack 2.00mm ID (0.079"),
5.50mm OD (0.217") Through Hole, Right Angle

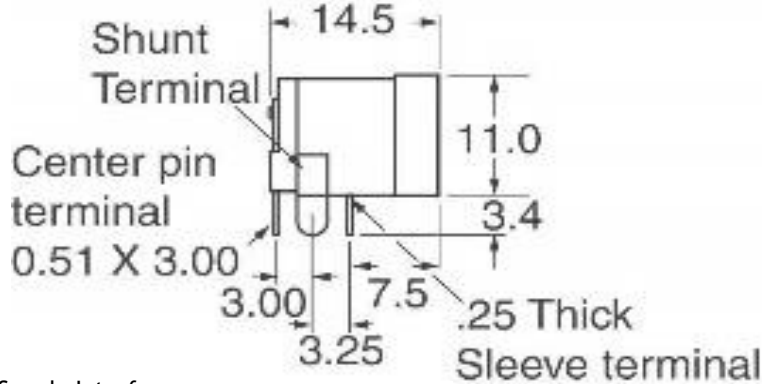

12V Wall Plug DC Power Supply Interface

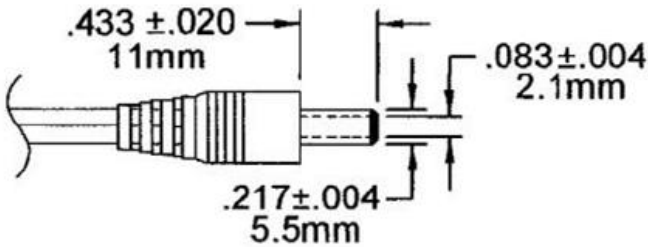

Product Dimensions

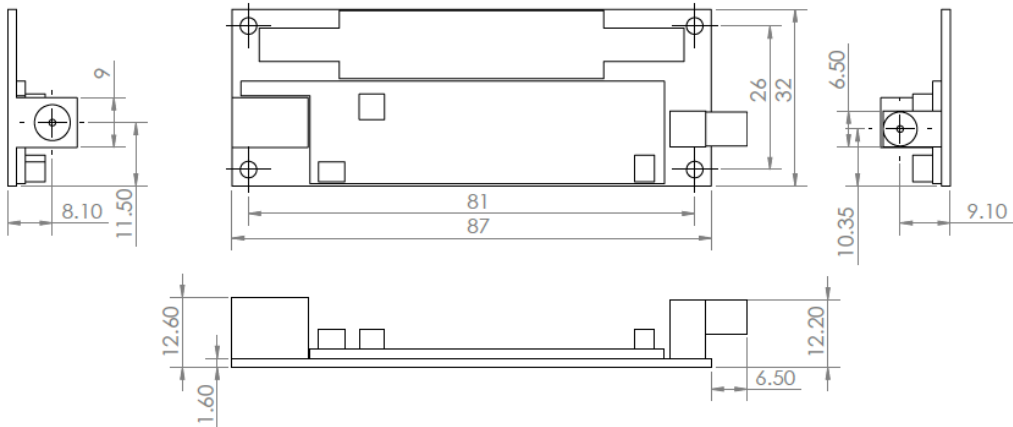

*Product dimensions may change without notice. This is sometimes required for non-standard specifications.